

A600

All you need for perfect coffee



MAKE IT
Wonderful!

FRANKE

TRUE PASSION LEADS TO INNOVATION

Every Franke coffee machine is packed with true passion and 100 percent Swissness. During product development, we learn from the experiences of restaurant operators, study the needs of coffee roasters and coffee lovers, and work tirelessly to further improve our products. The latest product resulting from this constant drive for innovation is the new A600.



INTELLIGENT AND USER FRIENDLY

As a truly intelligent coffee machine, the A600 redefines convenience. Enormously flexible, the A600's self-service capabilities dramatically improve efficiency in professional use.

The eight-inch color touchscreen with crystal clear resolution is the perfect interface for you and your guests. Intuitive menu prompts result in straightforward, efficient operation. The selection of beverages can be set individually and adapted to your exact requirements. Achieve additional sales through the exceptionally easy placement of advertising messages and custom images on the display. The ideal user interface is at your disposal to address every possible application and use.

Intuitive overview for self-service operation
Using a clearly understandable grid, guests place their order from an attractive menu of beverages. This can be customized easily with your own images. The desired beverage can be selected in the blink of an eye with a simple touch or swipe of a finger, and it's just as easy to set the cup size and the desired flavor.

Inspiring menu format

The large-format menu overview tempts users into selecting their own beverage creation. Inspiring images invite customers to explore an almost limitless range of beverages.

High volume efficiency

Large orders can be entered simply in a single step and then prepared one after the other at the touch of a button. This method supports service personnel and reduces their workload, reduces mistakes and makes it possible to exploit the full capacity of your machine.

Functional lighting concept for total control

The newly developed LED lighting concept not only gives the central display a stylish appearance, it also issues warning messages (such as "Caution: hot drink being prepared") and operator messages (such as "Add coffee beans or milk" or "Empty the coffee grounds container"). This gives you total control at all times and at any distance.



THE DETAILS MAKE THE DIFFERENCE

SELECTION FROM THREE DIFFERENT BREWING UNITS - OPTIMALLY ADJUSTED TO YOUR WAY OF MAKING COFFEE

THE INTUITIVE TOUCHSCREEN MAKES OPERATION SIMPLE AND EFFICIENT, AND CAN BE CONFIGURED TO YOUR INDIVIDUAL REQUIREMENTS

FUNCTIONAL LIGHTING CONCEPT

PERMANENT WATER SUPPLY CONNECTION OR TANK (4 LITER) AVAILABLE

AUTOMATICALLY ADJUSTABLE BEVERAGE SPOUT

REMOVABLE DRIP TRAY (3 LITER) WITH LEVEL MONITOR*
*only with models A600/A600 MS EC

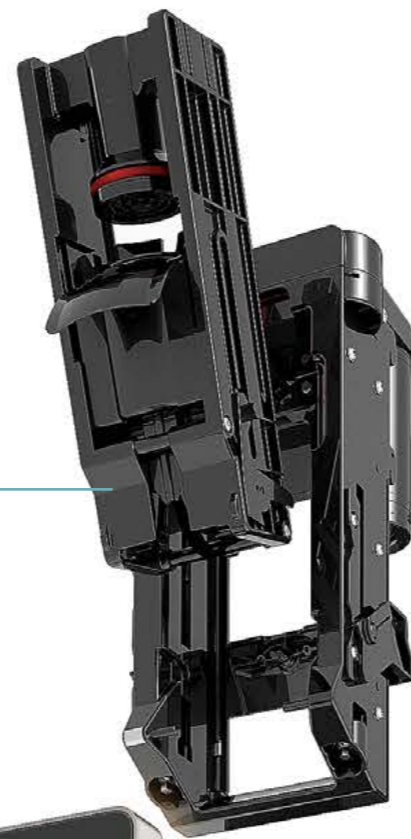

LOCKABLE COVER (OPTIONAL)

GENEROUSLY SIZED BEAN HOPPER FOR SIMPLE REFILLING (2x1.2 KG OR 1x2 KG)

TWO SEPARATE POWDER CONTAINERS (2x2.2 LITER)

SIMPLE SETTING OF GRINDING COARSENESS

MAXIMUM ENERGY EFFICIENCY THANKS TO A TIMER FUNCTION AND MINIMAL POWER CONSUMPTION IN STANDBY MODE

STEAM SPOUT
AUTOSTEAM /
AUTOSTEAM PRO

INNOVATIVE SWISS TECHNOLOGY FOR PERFECT COFFEE ENJOYMENT

When it comes to making coffee, the core process is and always will be extraction. Our researchers are always looking for increasingly sophisticated methods. This is exactly the reason why our coffee machines set such a high standard for others to meet. Our machines are a testament to true Swiss quality in every regard.

It is factors such as taste and quality that distinguish a good cup of coffee from a superb one. Extraction is the deciding factor when brewing coffee, with the goal of getting the absolute best from the beans. The new A600 optimizes this process and ensures perfect results in every cup.

Franke has selected only the best components for the A600 and combined them to create a state-of-the-art system. This consistency can be seen as soon as you open the practical, easily accessible bean hopper. Its shape ensures that the machine is extremely easy to fill, as well as making sure the beans continue to move optimally through the feeder.

The bean hopper can be removed easily using the central unlocking mechanism on the front of the machine. This then gives you direct access to the coarseness settings in the ceramic grinder – and all without the use of any tools. The precision grinding discs are extremely robust and have a long service life, which results in consistently uniform grinding results.

A further innovation in the A600 is the brewing unit, which can also be replaced easily without any tools. The heart of this fully automatic machine can be removed with just a few clicks. You can select from three different brewing units according to your own specific needs:

- For predominantly single cups of specialty coffees and for a perfect espresso: 43 mm brewing unit
- For predominantly two cups at once and for large cups: 50 mm brewing unit
- For predominantly brewed coffee and single cups of classic coffee: patented needle filter



Patented, easy-to-replace brewing unit



BEAN HOPPER

PATENTED BREWING UNIT,
REMOVABLE FROM THE FRONT

PRECISION BEAN GRINDER
WITH LONG-LIFE CERAMIC BURRS

SIMPLE HANDLING FOR MAXIMUM CLEANLINESS

Complying with the most stringent hygiene standards is a matter of course for Franke. That's why the A600 now also comes with CleanMaster, the fully automatic cleaning system. Once the cleaning process is started, the milk cleaning sequence is executed automatically from start to finish and the machine goes into energy-saving mode once it's done. So you can enjoy a spotlessly clean A600 at all times with the greatest of ease.

A new standard of convenience

The A600 boasts an advanced integrated cleaning concept that minimizes your workload and guarantees clean, safe handling. From now on, milk and cleaning agent spills are a thing of the past. Just swap out the milk container for the cleaning container. Choose from the automatic cleaning system EasyClean, which requires the cleaning fluid to be added manually, or CleanMaster, the fully automatic cleaning system with an integrated cleaning cartridge.

Hygienic, practical milk container system

- Hose-free docking system for the milk container
- Integrated sensor for efficiently measuring the milk temperature
- Integrated cleaning cartridge

Efficient cleaning process

- Automated process with integrated cleaning cartridge
- Safe and practical thanks to a separate cleaning container
- Highest level of cleanliness thanks to specially developed milk and coffee cleaning agents
- Maximum convenience: the cleaning process is ended automatically by the machine
- Conforms to HACCP

MILK CONTAINER (5 LITER) WITH INTEGRATED TEMPERATURE SENSOR AND DOCKING SYSTEM



CLEANMASTER ON/OFF SWITCH

MILK TEMPERATURE DISPLAY

LOCKABLE



CLEANING CONTAINER WITH INTEGRATED DOCKING SYSTEM

THE CLEANING AGENT CARTRIDGE

ONLY PERFECTION IS GOOD ENOUGH

Our highest priority is the perfect beverage and thus satisfied customers. The A600 meets this high standard in every regard. You will be thrilled with the complete taste experience.

Endless possibilities with hot and cold milk, hot and cold milk foam and flavors

The FoamMaster™ is your key to virtually infinite beverage options, including flavored milk and coffee specialties – from a perfect latte macchiato through to a classic espresso or a refreshing strawberry milk – and much, much more. Thanks to the milk processing system, chocolate dosing system and Flavor Station which holds up to three different syrups, it masters every possible drink option. Make your selection and indulge yourself!

Coffee

From dark classics to milky beverages and flavored coffees, the A600 excels in creating all products from the world of coffee, and all with a quality, authenticity and precision that will excite any coffee lover.

Chocolate

The double powder dosing system allows the use of two different chocolates and enables the preparation of all types of chocolate specialties. The FoamMaster™ creates the perfect mix of milk, creamy smooth foam and chocolate at the touch of a button.

Milk

Enjoy hot and cold milk foam as if it has been prepared by hand in the consistency you prefer. The short foaming time is particularly gentle, and only uses the amount needed. This efficient milk foaming system reduces milk waste and can cut calorie content.

Flavor

Thanks to the optional Flavor Station, you can enhance your beverages with up to three different flavored syrups. Combine your coffee beverage or milk with your favorite flavor – the FoamMaster™ makes your drink come to life at the touch of a button, from a fruity milk drink to a warming caramel latte macchiato.



UNIQUE VARIETY!

AS INDIVIDUAL AS YOU



MILK SYSTEMS (1)

- FoamMaster™ (FM): hot and cold milk and milk foam, individually adjustable consistency, integrated cleaning system
- Milk system (MS): hot and cold milk and warm milk foam, exact dosing via milk pump

CLEANING SYSTEMS (1)

- CleanMaster (CM): fully automatic cleaning system with integrated cleaning cartridge. For outstanding hygiene and unbeatable simplicity, efficiency, and convenience.
- EasyClean (EC): automatic cleaning system with manual addition of the cleaning fluid. Perfect hygiene in just a few steps.

A600 OPTIONS (2)

- Second bean grinder
- 1 × 2 kg or 2 × 1.2 kg bean hopper, lockable
- One or two separate powder dosing systems (for chocolate or milk powder), lockable
- Coffee grounds ejector
- Cup sensor
- M2M/telemetry
- Accounting system
- Raised feet (100 mm)
- Steam spout, Autosteam (enhanced milk foaming) or Autosteam Pro (automatic milk foaming)

FLAVOR STATION (3)

Automatic dosing station for up to three flavors

ACCOUNTING SYSTEM (4)

Can be used for various payment methods, e.g. with coins, card etc. Ideally suited to public/private vending applications.

CUP WARMER (5)

With four heatable trays

COLORS

- Black/chrome
- Anthracite/chrome

MAXIMUM FLEXIBILITY



PRODUCT SPECIALTIES	A600	A600 MS EC	A600 FM CM	A600 FM EC
Ristretto Espresso	✓	✓	✓	✓
Coffee Café crème	✓	✓	✓	✓
Brewed coffee	✓	✓	✓	✓
Cappuccino Latte macchiato	(✓)	✓	✓	✓
Chococcino	(✓)	✓	✓	✓
Chocolate	✓	✓	✓	✓
Hot milk	(✓)	✓	✓	✓
Hot milk foam	(✓)	✓	✓	✓
Cold milk		✓	✓	✓
Cold milk foam			✓	✓
Flavors			✓	✓
Hot water Steam	✓	✓	✓	✓

SWISS MADE

FOR COMPLETE FLEXIBILITY

Tailored precisely to your needs.
The following accessories can be combined with the A600:



REFRIGERATION UNIT SU05/SU12 THE ELEGANT SOLUTION

- Refrigeration unit in product design (available in 5l CM and EC/12l EC), lockable
- Perfect hygiene: intelligent milk hose coupling for contact-free filling
- Fill level alerts via the A600 display
- Top storage surface functions as heatable cup rack, with on/off switch
- Under-counter installation option (available in 5l EC/12l EC)



KE200 THE MINI MARVEL

- Refrigeration unit (4l), lockable
- Suitable for small to mid-range capacities



CHILL & CUP THE SPACE-SAVER

- Combination of lockable refrigeration unit (5l) with two heatable cup racks (80 cups)
- Suitable for small to mid-range capacities



BASE REFRIGERATION UNIT THE SPACE MAGICIAN

- Refrigeration unit (5l), lockable
- Suitable for use as a machine base (for professional food service or convenience applications)
- Suitable for mid-range capacities when space is limited on the counter



FLAVOR STATION THE FLAVOR WIZARD

- Dosing station with three syrups, automatic dosing, lockable
- Can also be fitted with liquors
- Available with heatable cup storage on upper shelf, with on/off switch



ACCOUNTING SYSTEM THE MONEY MAESTRO

- Can be used for various payment methods, e.g. with coins, card etc.
- Ideally suited to public/private vending applications
- Can be combined with M2M features

TECHNICAL DATA FOR A600 WITH ACCESSORIES, PLUS ADDITIONAL COMPATIBLE ACCESSORIES

MACHINE MODELS

MODEL	POWER
A600	220-240V 1LNPE 50/60Hz 2.4-2.8kW (13/15/16*A)
A600 MS EC	220V 1LNPE 50Hz 2.4kW (16A)
A600 FM CM	220-220V 2LPE 60Hz 4.5-5.3kW (30A) 230V 1LNPE 50/60Hz 2.1-2.3kW (10A) 200V 2LPE 50/60Hz 2.0kW (15A)
A600 FM EC	200-240V 1LNPE 50/60Hz 2.4-2.8kW (13/15/16*A) 380-415V 3LNPE 50/60Hz 6.3-7.5kW (16A) 220-240V 1LNPE 50/60Hz 4.4-5.0kW (30A) 220-240V 3LPE 50/60Hz 5.6-7.9kW (30A) 200V 2LPE 50/60Hz 2.0kW (15A) 200V 2LPE 50/60Hz 4.5kW (30A) 200V 3LPE 50/60Hz 6.8kW (30A) 220V 1LNPE 50Hz 2.4kW (16A) 380V 3LNPE 50Hz 6.3kW (16A) 200-220V 2LPE 60Hz 4.5-5.3kW (30A)
Dimensions:	340mm / 730mm / 600mm (W/H/D)

COLOR OPTIONS

Black/chrome or anthracite/chrome

WATER CONNECTION

Fixed water connection	Metal hose with union nut G 3/8", L = 1500mm
Water supply line	If possible on installation side: untreated water of drinking water quality (not from household decalcification system)
Water pressure	80 to 800kPa (0.8 to 8.0bar)
Total hardness	4-8 °dH GH (German total hardness) / 7-14 °fH GH (French total hardness) / 70-140 ppm (mg/l)
Carbonate hardness	3-6 °dH KH (carbonate hardness) / 50-105 ppm (mg/l)
Acid content/pH value	6.5-7.5 pH
Chlorine content	<0.5 mg/l

WATER DRAIN

Drain hose Dia. = 16 mm, L = 2000 mm

ACCESSORIES

1) REFRIGERATION UNIT	SU05 EC (5 I)
Electrical connection:	220-240V 1LNPE 50/60Hz 0.72A (10A) 120V 1LNPE 60Hz 1.5A (10A) 220V 1LNPE 50Hz 0.72A (10A) 100V 1LNPE 50/60Hz 1.65A (10A)
Dimensions:	270mm / 540mm / 475mm (W/H/D)
Weight (empty):	approx. 20 kg
Compatible with:	Model A600 MS EC / A600 FM EC
Colors:	Black or anthracite
1) REFRIGERATION UNIT	SU05 CM (5 I)
Electrical connection:	220-240V 1LNPE 50/60Hz 1.95-2.3kW (10A) 120V 1LNPE 60Hz 1.44kW (15A) 220V 1LNPE 50Hz 0.72A (10A) 100V 1LNPE 50/60Hz 1.35kW (15A)
Dimensions:	270mm / 540mm / 475mm (W/H/D)
Weight (empty):	approx. 24 kg
Compatible with:	Model A600 FM CM
Colors:	Black or anthracite

* Fuse varies by country

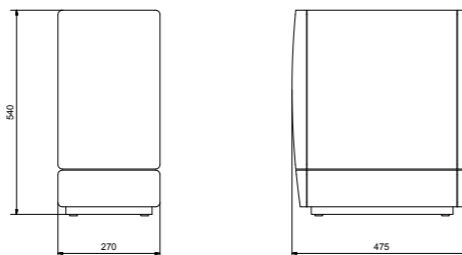
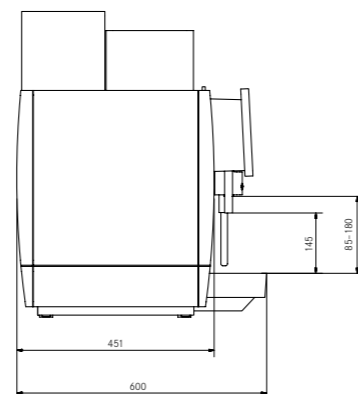
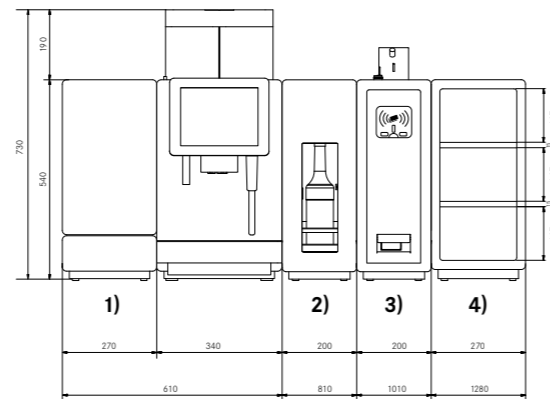

REFRIGERATION UNIT	SU12 EC (12 I)
Electrical connection:	220-240V 1LNPE 50/60Hz 0.72A (10A) 110-127V 1LNPE 60Hz 1.5-1.7A (10A) 220V 1LNPE 50Hz 0.72A (10A) 100V 1LNPE 50/60Hz 1.7A (10A)
Dimensions:	340mm / 540mm / 475mm (W/H/D)
Weight (empty):	approx. 28 kg
Compatible with:	Model A600 MS EC / A600 FM EC
Colors:	Black or anthracite

2) FLAVOR STATION	FS3
Electrical connection:	100-240V 1LNPE 50/60Hz 75W (10A)
Dimensions:	200mm / 542mm / 451mm (W/H/D)
Weight (empty):	approx. 18 kg
Compatible with:	Model A600 FM EC / A600 FM CM
Colors:	Black or anthracite

3) ACCOUNTING SYSTEM	AC
Electrical connection:	85-264V 1LNPE 50/60Hz (10A)
Dimensions:	200mm / 628mm / 451mm (W/H/D)
Weight (empty):	approx. 18 kg
Compatible with:	Model A600 / A600 MS EC / A600 FM EC / A600 FM CM
Colors:	Black or anthracite

4) CUP WARMER	CW
Electrical connection:	220-240V 1LNPE 50/60Hz 120W (10A) 110V 1LNPE 50/60Hz 80W (10A)
Dimensions:	270mm / 540mm / 453mm (W/H/D)
Weight (empty):	approx. 20 kg
Compatible with:	Model A600 / A600 MS EC / A600 FM EC / A600 FM CM
Colors:	Black or anthracite

REFRIGERATION UNIT	KE200 (4 I)
Electrical connection:	220-240V 1LNPE 50/60Hz 0.71A (10A)
Dimensions:	225mm / 507mm / 453mm (W/H/D)
Weight (empty):	approx. 13 kg
Compatible with:	Model A600 MS EC / A600 FM EC
Color:	Stainless steel

BASE REFRIGERATION UNIT	UC05 (5 I)
Electrical connection:	220-240V 1LNPE 50/60Hz 1.0A (10A)
Dimensions:	320mm / 238mm / 646mm (W/H/D)
Weight (empty):	approx. 27 kg
Compatible with:	Model A600 MS EC / A600 FM EC
Color:	Stainless steel

CHILL & CUP	CC
Electrical connection:	220-240V 1LNPE 50/60Hz 1.0A (10A)
Dimensions:	380mm / 581mm / 473mm (W/H/D)
Weight (empty):	approx. 29 kg
Compatible with:	Model A600 MS EC / A600 FM EC
Color:	Black

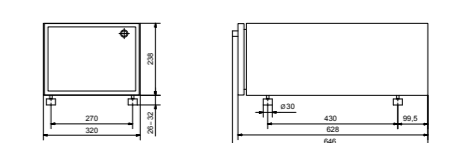
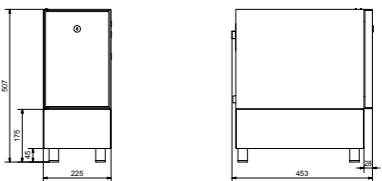
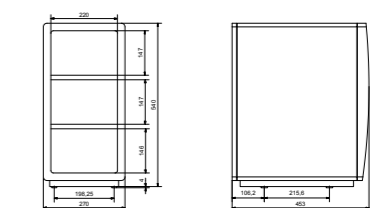
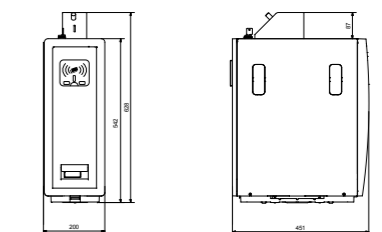
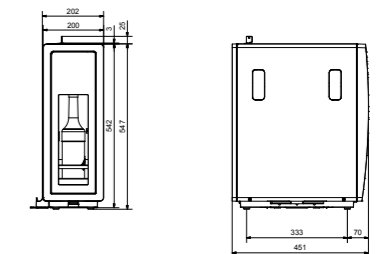
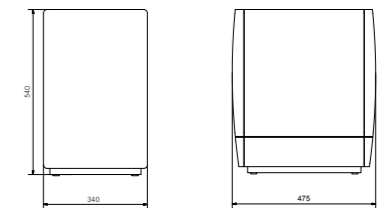



Franke Kaffeemaschinen AG
Franke-Strasse 9
4663 Aarburg
Switzerland
Phone +41 62 787 31 31
www.franke.com

Franke Coffee Systems GmbH
Franke Strasse 1
97947 Grünsfeld
Germany
Phone +49 9346 9278 0
Fax +49 9346 9278 100
www.franke.de

Franke Coffee Systems
UK Limited
6A Handley Page Way,
Old Parkbury Lane,
Colney Street,
St Albans,
Hertfordshire, AL2 2DQ
Phone +44 1923 635700
Fax +44 1923 635701
www.franke.com

Franke Coffee Systems
North America
800 Aviation Parkway
Smyrna, TN 37167
USA
Phone +1 615 462 4265
Fax +1 615 462 4400
www.franke.com

FRANKE